

DRIP IRRIGATION DESIGN & INSTALLATION GUIDE

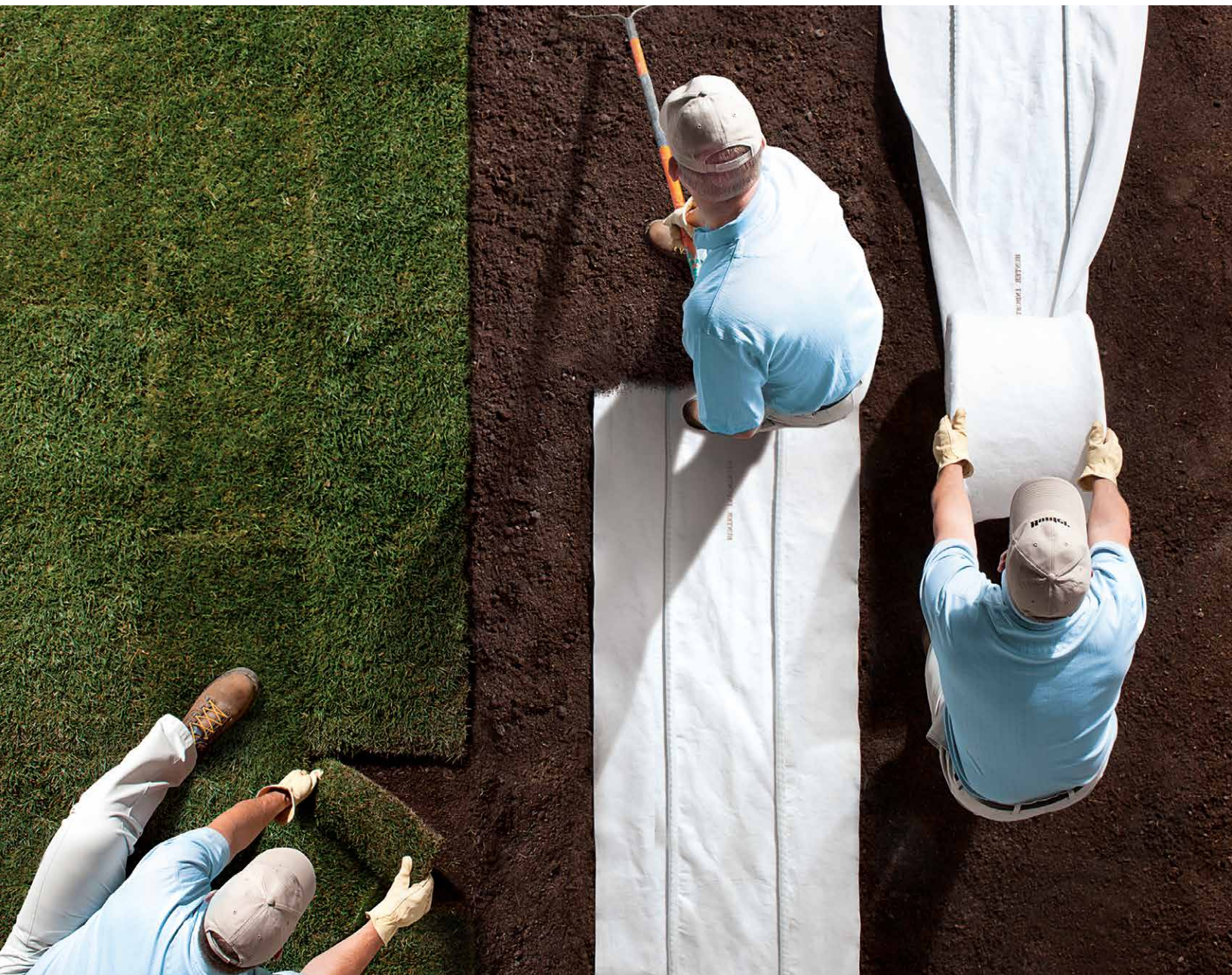

TABLE OF CONTENTS

Introduction

- 1** About This Technical Guide
- 1** About Hunter Industries
- 2** PLD
- 3** Eco-Wrap
- 4** Eco-Mat®
- 5** About Inline and Subsurface Drip
- 6** Applications
- 7** Limitations

Design

- 8** Water Quality
- 8** Soil Type and Water Movement
- 10** Components of an Inline Drip System
- 20** Calculations

Installation

- 21** Preparation
- 22** Procedure

Operation and Maintenance

- 24** Initial Operation
- 25** Scheduling
- 26** Maintenance

Appendix A: Example Installation Details

Appendix B: Technical Product Data

- 28** Coefficient of Variation
- 28** PLD
- 28** Eco-Wrap
- 29** Eco-Mat
- 29** Fittings

INTRODUCTION

The combination of PLD, Eco-Wrap®, and Eco-Mat provides a comprehensive suite of inline drip irrigation products for landscape professionals. Together, they are designed to efficiently irrigate any planted area.

Irrigation's most basic function is to provide water where and when it is needed. Irrigation is not provided directly to plants, but to the root zone of the soil. The root zone functions as a reservoir and is highly dependent on plant type, soil type, soil compaction, and other factors.

Traditional irrigation projects water through the air. As water floods the surface, gravity is used to distribute water through the root zone. Distribution of water through the air is dependent on the ability of emission devices to project water evenly and within the boundaries of the target area. External factors such as wind and heat increase evaporation, affect droplet cohesion, pattern

distribution and cutoff, and frequently result in overspray. The result? Significant water waste.

Hunter's inline drip products use capillarity to move water in all directions through the root zone. Water is distributed with maximum uniformity in all directions, providing the right amount of water exactly where needed to stimulate and sustain healthy root growth. When used below grade, inline drip irrigation significantly limits the loss of water through evaporation.

Eco-Mat supplements the soil's ability to provide water by increasing the carrying capacity through pore space inherent in the polypropylene fleece mat. This is especially useful for applications with limited natural water-carrying capacity such as highly permeable soils and planting media.

ABOUT THIS TECHNICAL GUIDE

This guide outlines the application, design, and installation of Hunter's inline drip products that provide designers, installers, and irrigation managers a new class of irrigation technology. It is written for professionals who have a solid understanding of basic irrigation and design practices. Technical information for the specification, design, installation, and operation of Hunter inline

drip products, including PLD (Professional Landscape Dripline), Eco-Wrap, and Eco-Mat, are included.

Information is organized sequentially; moving front to back in the order you'll need it most. Under each topic essential information is placed at the beginning and becomes progressively more detailed.

ABOUT HUNTER INDUSTRIES

Hunter Industries is a family-owned global company that provides high quality, efficient solutions for the irrigation, outdoor lighting, and custom manufacturing industries. Headquartered in San Marcos, California since 1981, Hunter is a market leader in producing and marketing a full range of water-efficient, easy-to-use irrigation solutions for residential, commercial, and golf course applica-

tions. Designed with the demands of irrigation professionals in mind, the current Hunter irrigation product line includes pop-up gear-driven rotors, high-efficiency rotary nozzles, spray sprinklers, valves, controllers, central controllers, professional landscape drip and inline drip products, and weather sensors.

PROFESSIONAL LANDSCAPE DRIPLINE

PLD is professional grade inline drip tubing that incorporates the strongest UV inhibitors available, check valves, and pressure-compensating emitters with redundant emission paths. Hunter PLD is widely regarded as a highly efficient, reliable drip solution.

PLD is suitable for at-grade, temporary, shallow subsurface, and living wall applications for a variety of plant material including groundcovers, grasses, shrubs, and trees. PLD is available in a wide range of emitter flow rates and spacing.

- PLD is offered in a range of flow rates, including 0.4 GPH, 0.6 GPH, and 1.0 GPH
- PLD has an operating range of 15 to 50 PSI (emitters are pressure compensating within this range)
- Built-in check valves hold up to 5 ft. of head, preventing low emitter drainage and water waste
- PLD tubing has a tested burst pressure of 260 PSI
- The strongest inhibitors available provide superior resistance to UV degradation for on-grade applications
- Two emitter paths provide redundancy and extra protection against clogging

PLD Drip Tubing

Professional-grade inline drip tubing



ECO-WRAP

Eco-Wrap is PLD encased in polypropylene fleece. The polypropylene wrap addresses two issues with other subsurface irrigation systems: root intrusion and poor capillary action of the soil. Eco-Wrap overcomes these challenges and provides significant advantages over typical inline drip tubing without the use of chemicals or harmful metal residue, while accelerating lateral water movement and greatly increasing emission area and uniformity.

Eco-Wrap is recommended for all subsurface applications for all types of plant material. Where freely draining soils or planting media are anticipated, Hunter recommends Eco-Mat.

- Hunter Professional Landscape Dripline includes check valves and pressure compensating emitters at 0.6 GPH at 12" spacing
- Emitters saturate the fleece wrapping, which speeds lateral movement and distribution throughout the root zone
- Capillary action wicks water through the fleece and into the soil in a widely distributed manner, reducing the potential for tunneling or water waste due to gravity
- Unlike other products, the polypropylene fleece wrap provides protection from root intrusion without using toxic chemicals, metal byproducts, or any other products with a limited lifespan



ECO-MAT®

Eco-Mat uses a unique combination of specialized PLD and polypropylene fleece, which evenly disperses water throughout the target area. Eco-Mat also supplements the water holding capacity of the soil. Each square yard holds approximately one half gallon of water, available directly to the root zone of the plant material. This is especially useful in turf and applications that use rapidly draining planting media such as rooftop gardens.

Eco-Mat is recommended for subsurface applications in traditional planters, intensive and extensive rooftop gardens for turf and sod-forming plant types, and shrubs and smaller plants with root zones generally 12" or less. Eco-Mat is ideal for completely uniform distribution, and particularly suited for freely draining soils and engineered growing media.

- Special engineered polypropylene fleece fabric mat, provides distribution to nearly 100% of the irrigated area
- Fleece mat supplements the soil's natural water holding capacity
- Uses Hunter Professional Landscape Dripline with check valves and pressure compensating emitters at 0.6 GPH at 12" spacing
- Emitters saturate the wrapped tubing and then the Eco-Mat with water. Once saturated, Eco-Mat provides water to the entire landscaped area through capillary action
- Unlike any other product, Eco-Mat provides nearly 100% distribution uniformity by using dispersed emission throughout the entire irrigated area

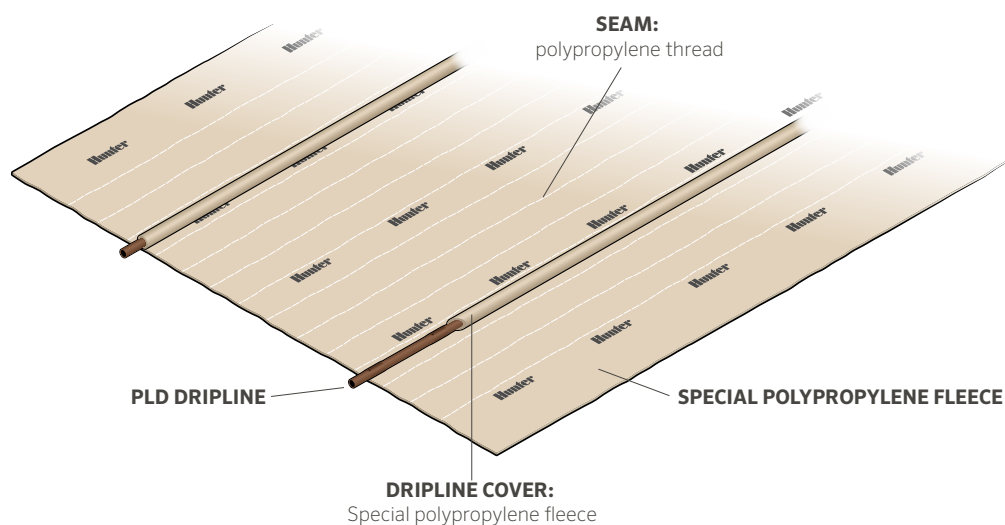

LEED Water Efficiency (written from standpoint of LEED 2012)

Hunter products contribute significantly to LEED BD+C Water Efficiency (WE) Credits. Beginning in 2012, LEED BD+C uses the US EPA's WaterSense Water Budget Tool instead of local requirements to calculate a project's water use baseline. Savings of 50% or more beyond the baseline provide an additional credit. Water savings can be achieved using PLD, Eco-Wrap, or Eco-Mat to irrigate all types of plant material that require a subsurface solution. Since its distribution uniformity approaches 100%, Eco-Mat will provide the highest degree of savings. Total water savings can be enhanced by using one of Hunter's weather sensors such as Solar Sync or ET System.

The Sustainable Sites Initiative

The Sustainable Sites Initiative (2009) uses the same baseline approach as LEED 2012 to calculate irrigation water use. Hunter products provide significant water savings to achieve prerequisite 3.1 and to potentially achieve credit 3.2. Hunter drip irrigation and other products, such as ET-based controllers and MP Rotators, provide significantly higher efficiencies than the baseline calculation assumes.

Discussion of California MWELO (AB 1881)

In 2010, California instituted a statewide requirement known as the Model Water Efficient Landscape Ordinance. This ordinance restricts the volume of applied water allowed, and with few exceptions, prohibits overhead irrigation within 24" of hardscape, or shrub areas. Many more states are monitoring the effectiveness of this ordinance in reducing overspray and runoff and may follow suit. PLD, Eco-Wrap, and Eco-Mat provide the ideal irrigation solution for these areas.

ABOUT INLINE AND SUBSURFACE DRIP

Inline drip is ideal for all types of planted areas, including specialized sports applications, parks, streetscapes, commercial, and residential landscapes. Installing the emission system under the surface reduces or eliminates damage from heavy traffic, vandalism, ultraviolet degradation, and impact.

Other types of irrigation systems require an exact pressure to maintain their pattern and distribution. As pressures change, the performance of these systems degrades substantially. By contrast, inline drip irrigation allows very high distribution uniformity even at low or varying pressures.

Inline drip can significantly reduce water waste while stimulating plant growth by providing the optimum water content to soil, avoiding “flood and drought” cycles that cause root dieback, and avoiding anaerobic conditions. Subsurface applications further reduce water waste through evaporation.

Drip irrigation is an ideal solution for irregular or small areas. Inline drip irrigation limits the potential for liability by reducing or eliminating overspray on buildings, walkways, roadways, and other trafficked areas. Maintenance costs are often lower due to reduced overspray, runoff, erosion, compaction, water staining, and property damage. With no exposed emission equipment to get vandalized, stolen, damaged, misaligned, or worn out, material costs over the life of a project are substantially lower.

A fertilizer injection (fertigation) system—for chemical or organic products—can be easily introduced to inline drip systems and distributed directly to plant root zones. This avoids human and animal contact and provides a more even distribution of material, minimizing material cost.

An injection system also provides the ability to maintain inline drip tubing by controlling mineral or biological buildup by periodically injecting mild acid or trace amounts of chlorine.

Where water supply or irrigation scheduling is problematic, subsurface irrigation may be used to extend the watering window. Irrigation can be scheduled anytime, even during active use, without worry about increased evaporation during the day. Extending the watering window may allow lower flows, resulting in significant savings through reduced connection fees and materials costs.

All Hunter inline drip products feature a specially engineered emitter that includes:

- Dual turbulent flow paths that promote scouring to prevent clogging from debris and dissolved minerals
- Built-in check valve preventing low-emitter drainage, retaining up to 5 ft. of water
- Pressure compensation across a wide range of pressure, from 15-50 PSI
- Robust construction preventing crushing or internal emitter damage even under heavy use

24 Hour Advance Watering

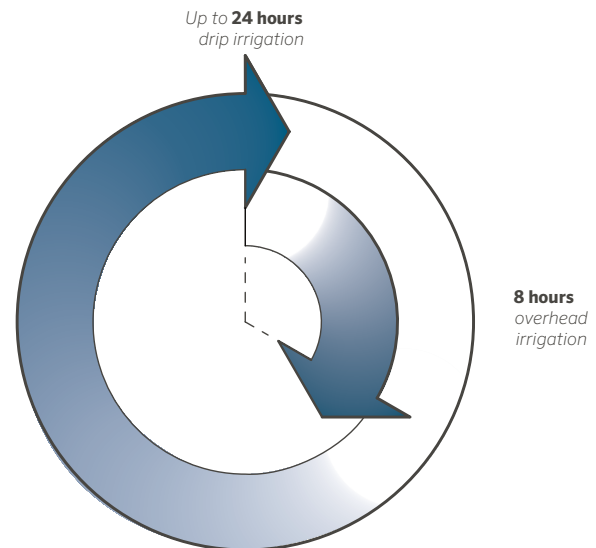

Inline Emitter

Features dual turbulent flow paths that promote scouring to prevent clogging from debris and dissolved minerals



APPLICATIONS

APPLICATIONS			
Plant Type Application	Hunter PLD	Hunter Eco-Wrap	Hunter Eco-Mat
Temporary irrigation	X		
Groundcovers, shrubs, trees at grade (or less than 6" deep)	X		
Subsurface irrigation of grasses, turf, or other sod-type plants		X	X
Subsurface irrigation of groundcovers and small shrubs		X	X
Subsurface irrigation of trees and large shrubs		X	
Spreading succulents, moss, other mat-type plants		X	X

Landscape Area Type Application	Hunter PLD	Hunter Eco-Wrap	Hunter Eco-Mat
Low traffic areas	X	X	X
High traffic areas		X	X
Specialized sports applications, large turf areas		X	X
Irregular, small, or narrow areas; parking lot islands	X	X	X
Rooftop landscapes (intensive and extensive)		X	X
Living walls	X	X	X
Curved areas, borders, near vertical surfaces	X	X	X
Supplemental moisture for foundations and grounding	X	X	X

Rooftop Landscapes

Eco-Wrap and Eco-Mat are particularly suited for rooftop and other on-deck applications. Whether intensive or extensive, these applications typically use a freely draining lightweight planting media. Because this media has large particle size and pore volume, the capillarity of this media can be greatly reduced when compared to topsoil. Other irrigation systems quickly exceed the media's ability to move water via capillary action. Gravity takes over, moving water rapidly down through the media and into the drainage layer, resulting in water waste. Eco-Wrap and Eco-Mat widely distribute the point of emission, mitigating this problem.

Living Walls

PLD, Eco-Wrap, and Eco-Mat are ideal for irrigating living walls. Typically comprised of planted pockets supported and separated by fabric or other structure, these applications face the same challenges as rooftop landscapes. It's necessary to ensure that emitters are evenly spaced in the planted pockets by matching the inline spacing to the planted structure, or by splicing as required. When using Eco-Wrap or Eco-Mat with separated planting pockets, cut the fleece between the pockets to prevent wicking outside each cell. When using Eco-Mat, fold the fleece blanket to conform to the perimeter of each cell, maximizing contact with the planting media. Eco-Mat supplements the media's holding capacity, providing an extra reservoir of water.

LIMITATIONS

Subsurface irrigation has significant differences when compared to overhead irrigation. Maintenance practices must be scheduled regularly and are proactive, rather than reactive. Under certain conditions, supplemental irrigation may be required to:

- Grow in sod and other plants until they adapt to the subsurface irrigation system
- Wash salt, dirt, smog, or other deleterious material off foliage
- Water in granular and other topically applied fertilizers
- Sufficiently wet broadcast seed to assure even germination

Retaining Walls

Inline drip irrigation is ideal for all types of retaining walls, including walls with planted pockets, or just planted areas at the top or base of the wall. Its compact form allows irrigation even in the tightest of plant pockets. Inline drip prevents overspray and limits runoff, preventing damage to walls and limiting liability.

Retrofitting Existing Systems

PLD is ideal for surface application in existing shrub and groundcover areas where minimal disturbance is required. Adaptors easily convert existing sprinkler risers to 17 mm insert fittings for use with inline drip tubing. In turf areas Eco-Wrap can be trenched and backfilled. Where turf areas are being installed or replaced, consider Eco-Mat as a water-saving alternative to traditional irrigation systems.

Specialized Sports Applications

Inline subsurface drip provides a non-intrusive way to irrigate turf athletic fields while avoiding the compaction problems that plague traditional systems. Compaction is exacerbated by heavy use in saturated conditions and seriously affects playability and turf grass health. The use of capillary action to distribute water laterally (instead of overhead irrigation and gravity) avoids the flood and soak cycle that damages fields. Subsurface irrigation protects equipment from impact and sunlight, protects players from tripping, avoids impact hazards, and reduces maintenance and/or replacement.

Subsurface PLD applications should be reviewed for root intrusion potential, and should not be used at depths greater than 6". For all subsurface applications under turf, Hunter recommends Eco-Wrap or Eco-Mat.

DESIGN

Prior to designing a system, collect the following information:

- A scaled plan of the site and area to be irrigated
- Point-of-connection information, including static pressure and available flow
- Irrigation water type (potable, non-potable but treated, well, etc.) and characteristics
- Soil type (important for determining dripline emitter and line spacing)
- Proposed grading (used to determine inline tubing orientation and modify spacing or separate hydrozones where needed)
- Proposed planting, including relative water needs of all species, and sizes at planting and maturity
- Local conditions, including elevation differences, local climate data (ET_o), and other site specific information

WATER QUALITY

Water quality can significantly affect the operation and longevity of inline drip irrigation systems. Below are general parameters that can be identified by a water

quality test. Values less than or equal to the *low* column are ideal for inline drip irrigation.

CHEMICAL WATER QUALITY FOR THE CLOGGING POTENTIAL OF DRIP IRRIGATION

Description	Clogging danger with the following concentration		
	Low	Moderate	High
pH	< 7.0	7.0 – 7.5	> 7.5
Particulate matter*	< 30	30 – 100	> 100
Total dissolved solids*	< 500	500 – 2,000	> 2,000
Ferrous*	< 0.1	0.1 – 1.5	> 1.5
Manganese*	< 0.1	0.1 – 1.5	> 1.5
Calcium*	< 40	40 – 80	> 80
Carbonate density*	< 150	150 – 300	> 300
Hydrogen Sulfide*	< 0.2	0.2 – 2.0	> 2.0
Bacteria (quantity/ml)	< 10,000	10,000 – 50,000	> 50,000

* Concentration in mg per liter (mg/L) or parts per million (PPM)

SOIL TYPE AND WATER MOVEMENT

Soil texture affects water movement. Emitter flow rate, spacing, and line spacing must be adjusted to compensate. The table below provides general guidelines. When unsure about the exact classification, use the tighter spacing. Even if the application rate exceeds a soil's expected intake rate, proper application of water can be achieved through scheduling.

RECOMMENDED SPACING FOR BASIC SOIL TYPES

Soil Type	Clay	Loam	Sand
Emitter flow rate	0.4 GPH	0.6 GPH	1.0 GPH
Emitter spacing	24"	18"	12"
Row spacing	18" – 24"	16"-22"	12"-18"

Differences in recommended spacing and flow rates are due to the physical properties of soil as related to water movement.

In descending order of particle size, soil is broadly classified into sand, loam, and clay. Particle size affects capillarity. As particle sizes decrease, capillary forces increase. Greater capillary force allows more water movement through the soil in all directions. Lesser capillary force limits the amount of water movement. As more water is added, gravity begins to draw water downward. The downward movement of water due to gravity is greater for soils with larger particle size.

For soils with smaller particle size, emitters can be spaced farther apart because capillary force will draw water farther before gravity pulls it down. For soils with large particle size, water will almost immediately begin moving downward. Emitters must be spaced closer together to spread the water through lesser capillary action before it is lost below the root zone due to gravity. Use the following table as a guideline for spacing: If you are unsure of the exact soil type, or know that soils will differ on a site, use the minimum recommended spacing and the maximum recommended flow rate to ensure that water is evenly distributed.

SOIL INFILTRATION RATES

Soil Type	Maximum application rate (in/hr) on slopes		
	0-5%	5-8%	8-12%
Sand, coarse	1.5-2.0	1.0-1.5	0.75-1.0
Sand, fine	0.75-1.0	0.5-0.8	0.4-0.6
Loam, silt loam	0.3-0.5	0.25-0.4	0.15-0.3
Clay, clay loam	0.15	0.10	0.08

Soils of differing particle size will also accept water at differing rates. Soils with larger particles have larger voids, or pores, to accept water. Generally, the application rate of an inline drip system should not exceed the basic intake rate of the soil. (The basic intake rate of the soil is the rate at which the soil absorbs water after the initial application of water in a dry condition.) Basic intake rate estimates can be obtained from the USDA Web Soil Survey, or the table below. If the intake rate is exceeded by the irrigation system, water can be “pulsed” through the soil by scheduling several cycles of irrigation.

If a jar is not available, conduct a “ball” test to determine basic soil type: squeeze a moist ball of soil in your hand, then rub the soil between your fingers. Sand feels gritty, won’t form a ball, and will fall apart. Loam soil is smooth, slick, partially gritty, and forms a ball that crumbles easily. Clay soil is smooth, sticky, somewhat plastic feeling, and will form a ball that does not crumble easily.

Soil Types

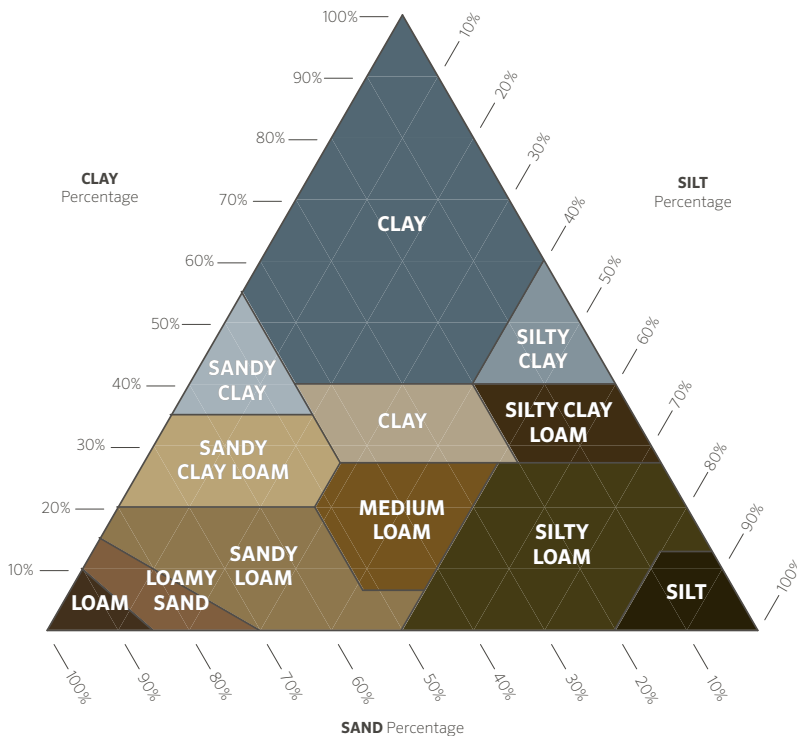

Soil Test Sample Jar



Determine Soil Type

Test the soil in the target area after all grading operations are complete and amendments have been incorporated. If a laboratory soil analysis is not possible, a simple field test to determine soil texture is to place a sample in a jar and fill half-way with water. Thoroughly shake the jar, ensuring the soil is suspended. Allow settling for at least 2 hours, then measure each layer to determine the percentage of each type (in ascending order: sand, loam, and clay).

COMPONENTS OF AN INLINE DRIP SYSTEM

This section addresses design considerations for each component of an inline drip system, moving from the valve downstream to the flushing device. For more information about other irrigation components, see <http://www.hunterindustries.com>.

Controller

A controller is the “brain” of every irrigation system. Hunter controllers provide effective tools for irrigation management. For projects larger than 30 zones, Hunter recommends the use of two-wire decoder technology, available for both ACC and I-Core controllers. For areas without AC power, Hunter’s wall mount or in-valve-box battery controllers are ideal. All controllers are compatible with PLD, Eco-Wrap, and Eco-Mat®.



Valve

A remote control valve is typically used to automatically activate inline drip systems. Alternatively, a manual valve or even hose bib may be used for non-automatic systems. Each hydrozone should be irrigated by a separate valve. Hydrozones are areas with specific conditions that affect irrigation, including plant type, spacing, density, microclimate, exposure, and slope.



Follow all local requirements to prevent backflow and back siphonage.

ET-Sensor

ET-based controllers optimize scheduling based on real-time weather conditions to minimize water waste due to management factors. Hunter’s Solar Sync ET sensor adds even more efficiency to inline drip project by automatically adjusting irrigation scheduling for changing weather and site-specific climate conditions. The Solar Sync is compatible with all AC operated Hunter controllers. Both installation and operation are simple processes.



Filter

Filtration must be provided for all inline drip systems, regardless of water supply type. Even potable water contains suspended particulates which may clog inline emitters. Filters also help reduce biological contaminants.

For large or distributed systems, consider a disk filter near the point of connection. This provides a single, easily maintained item in an accessible location. Use screen filters at each drip valve as a secondary level of protection in case any debris enters the irrigation system downstream of the primary filter.

Use a filter with a minimum filtration level of 120 microns (approximately 120 mesh, or 0.125 mm).

Inline Drip Tubing

Inline drip tubing consists of tubing laid in parallel rows. This creates a grid of emitters evenly spaced throughout the entire irrigated area.

Zone Control Kit

Every successful inline drip irrigation zone starts with three items: zone control, filtration, and pressure regulation. Hunter’s Drip Zone Control Kit combine all three into one factory-assembled, water-tested kit, which speeds up specification and installation. For more options, each component can be individually specified.

Pressure Regulation

All Hunter inline drip products feature built-in pressure compensation, allowing an inlet pressure of 15-50 PSI. For mainline pressures exceeding 50 PSI, use a pressure regulator downstream of the valve and filter.

Laterals

Laterals moving water from the valve to the header(s) must be sized to accommodate the full flow of each area they serve. Industry standards are not to exceed a velocity of 5 FPS. Laterals are typically PE or PVC pipe. They may also be constructed of blank inline drip tubing for smaller areas.

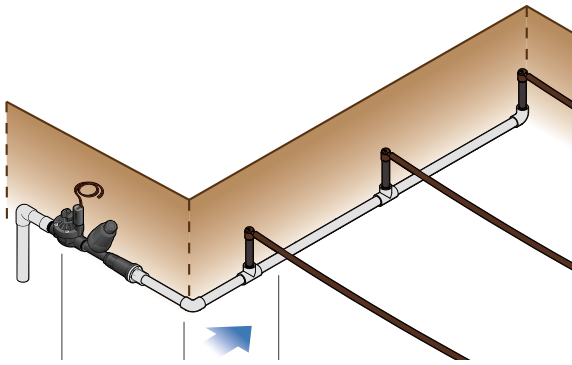

Sizing laterals and headers

Sizing supply headers and laterals is crucial to the proper operation of all inline drip systems. Perform a pressure loss calculation from the point of connection to the farthest end of each supply header. Size the header to provide the flow needed for the entire zone. Improperly sized headers and laterals may not allow proper emitter function.

Supply Header

Each supply header must be sized to accommodate the full flow of the entire area it serves. Headers may be either end-feed or center-feed configurations.

Barbed Fittings

Barbed insert fittings provide a positive connection to inline drip tubing. Hunter 17 mm insert fittings are color-matched with PLD, are UV resistant, handle pressures up to 200 PSI, and provide a positive, easy-to-install, watertight connection without using tools, clamps, or glue.



Air/Vacuum Relief (AVR) Valve

While Hunter inline drip emitters are designed to release air from the system and block back siphonage, AVR valves speed the process and provide an immediate path for large volumes of air to escape. They should be installed on the highest position of the each contiguous area of inline drip tubing. AVR valves must be used when automatic flush valves are specified to prevent back-siphonage through emitters during the initial flush cycle.

Exhaust Header

The exhaust header serves to equalize pressure and flow between runs of inline drip tubing and provide an outlet path for flushing. The exhaust header does not need to be sized to equal the supply header, but must be able to accommodate the flow rate of the flush valve, without exceeding 5 FPS.

Flush Valves and PLD Cap

Flush valves are required on every inline drip system and must be located to provide an outlet from every point in each zone. Regular flushing not only removes debris and particles from the tubing, but the high volume of turbulent water during flushing also helps dislodge biological growth. Flush valves can be either automatic or manual. The Hunter PLD barbed valve is an affordable option to flush the system.



LAYOUT

Typical zone layout consists of supply header(s) and exhaust header(s) with parallel lines of inline drip tubing between. These may be either center-feed or end-feed configurations.

Zone design and line layout follow these basic principles:

- **Layout:** Start with the longest side. Create parallel rows to fill the area. Identify supply and exhaust header locations, and connect the lines. Use returns or branches to follow curved edges.
 - **Slopes:** Lay inline tubing perpendicular to the slope (parallel to contours). In flat areas, lay tubing in straight lines, accommodating curved edges by returning or branching lines.
 - **Edges:** Hardscape edges and limits of planting are subject to wind, radiant heat, reflected sunlight, and other factors that increase evaporation and plant water needs. Place perimeter lines close to edges, typically $\frac{1}{4}$ of the regular on center spacing, but not greater than 4".
- **Maximum length:** To adequately supply all emitters, do not exceed the maximum run shown in the tables below. Remember to add the length of all branched runs.
 - **Line spacing:** Spacing should not be greater than shown in the tables below, but may be reduced as required to equally space lines within a zone or provide additional coverage. (Note: Increased spacing on the lower third of slopes is an exception to this guideline.)

EMITTER LINE LENGTH - 0.4 GPH				EMITTER LINE LENGTH - 0.6 GPH				EMITTER LINE LENGTH - 1.0 GPH			
Pressure (PSI)	Emitter Spacing (in.)			Pressure (PSI)	Emitter Spacing (in.)			Pressure (PSI)	Emitter Spacing (in.)		
	12	18	24		12	18	24		12	18	24
15.0	289	401	502	15.0	173	240	300	15.0	126	176	222
20.0	354	494	620	20.0	230	320	402	20.0	169	235	295
25.0	405	563	706	25.0	265	373	471	25.0	197	276	346
30.0	441	621	783	30.0	299	417	523	30.0	218	308	390
35.0	481	671	842	35.0	333	462	580	35.0	240	337	425
40.0	508	719	910	40.0	342	483	611	40.0	263	362	452
45.0	542	755	949	45.0	364	518	657	45.0	271	384	486
50.0	558	784	988	50.0	387	543	685	50.0	288	401	503

Center-Feed Layout

Center-feed layouts allow larger areas to be served with one zone and maximize the length of a zone. This is ideal for medians or parkway strips. Center-feed layouts require exhaust headers at each end.

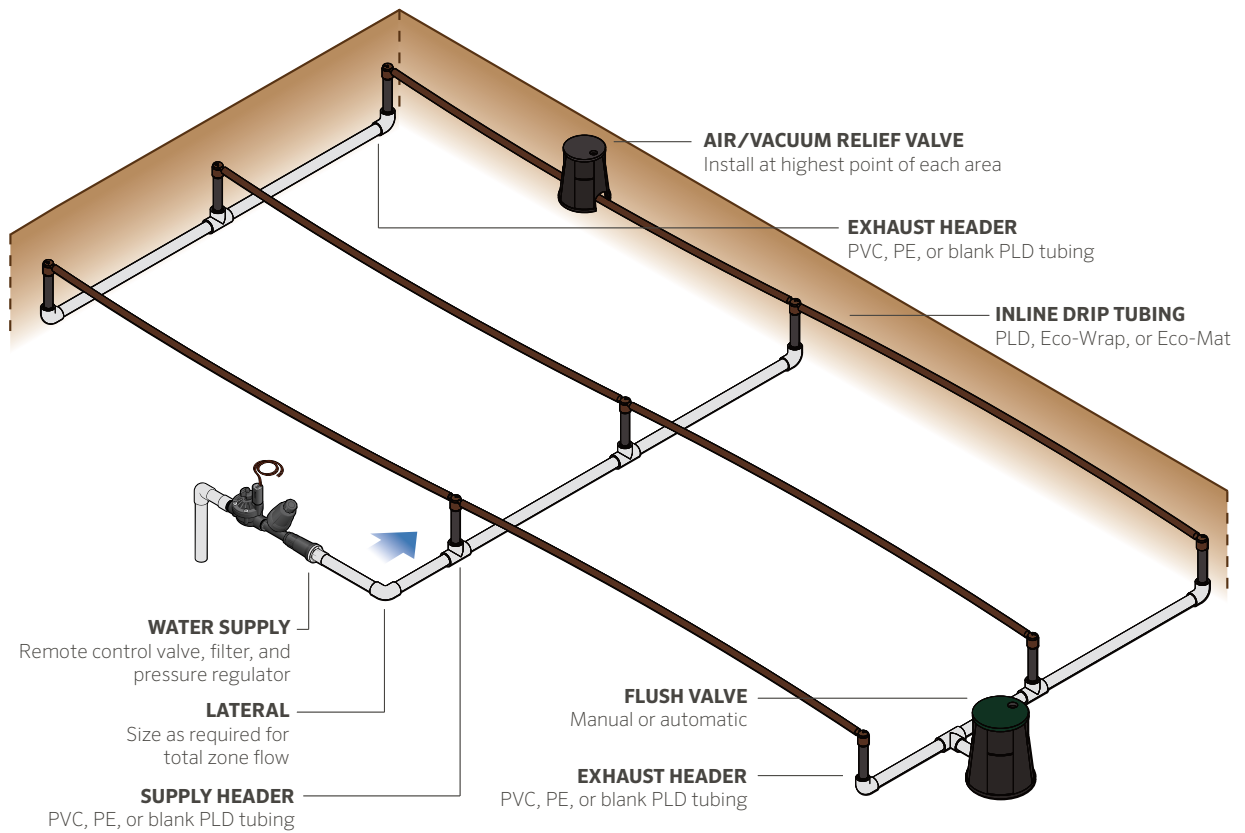

End-Feed Layout

End-feed headers typically reduce piping costs and labor for smaller areas. Use end-feed layouts for sloped zones with the supply header located above or at the top of slope.

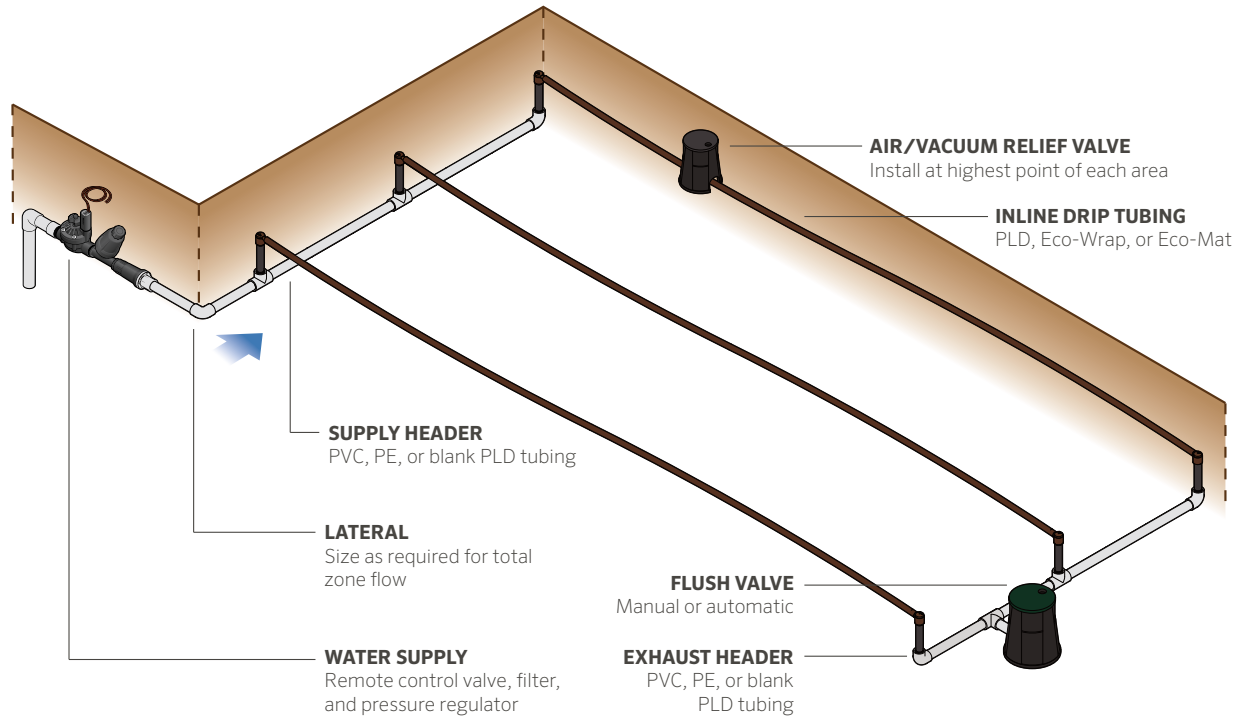

Edge Conditions

Follow curves and irregular shapes by “branching” to either terminate or extend inline drip tubing rows. When extending, be sure to add each branched row to the total length of the original row connected to the header and not to exceed the maximum length allowable.

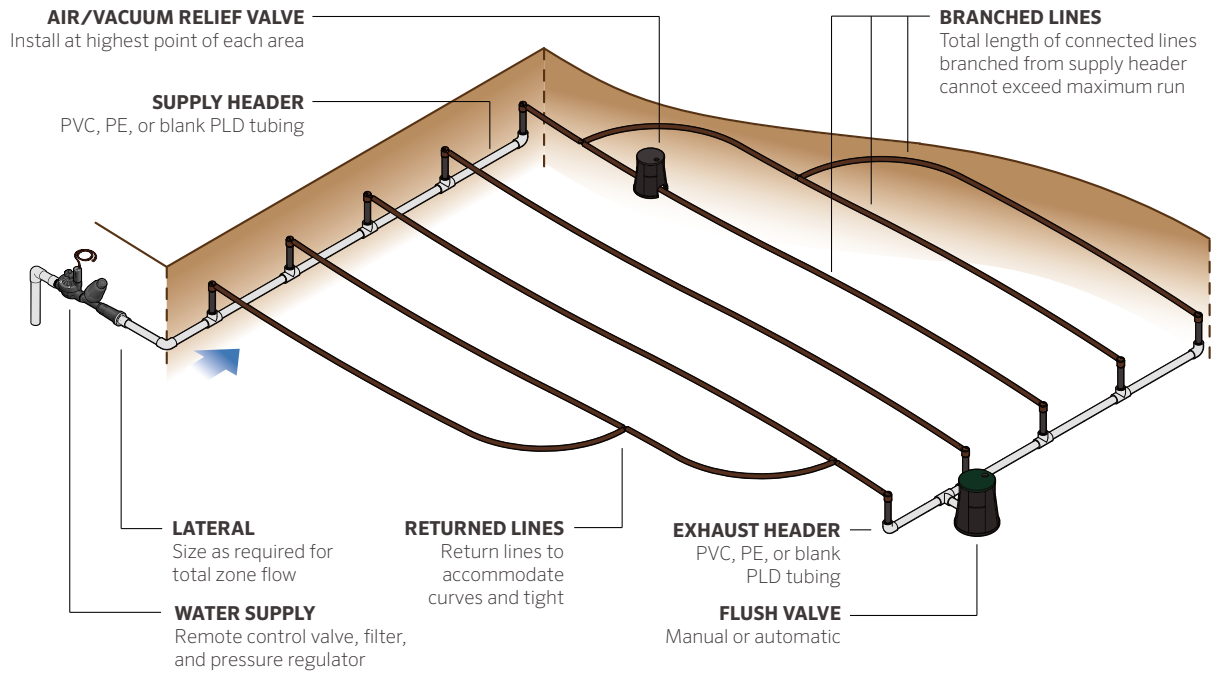

“Light” Layout

Small areas with little or no slope may be irrigated by one loop of inline drip tubing laid in a snaking pattern. This method is economical, but limits the irrigated area by the maximum tubing length (because the loop is fed from both ends, it cannot exceed twice the “maximum run distance” in the illustration below). In this case, supply and exhaust headers may be eliminated. Locate air relief and flushing valves directly off the inline tubing.

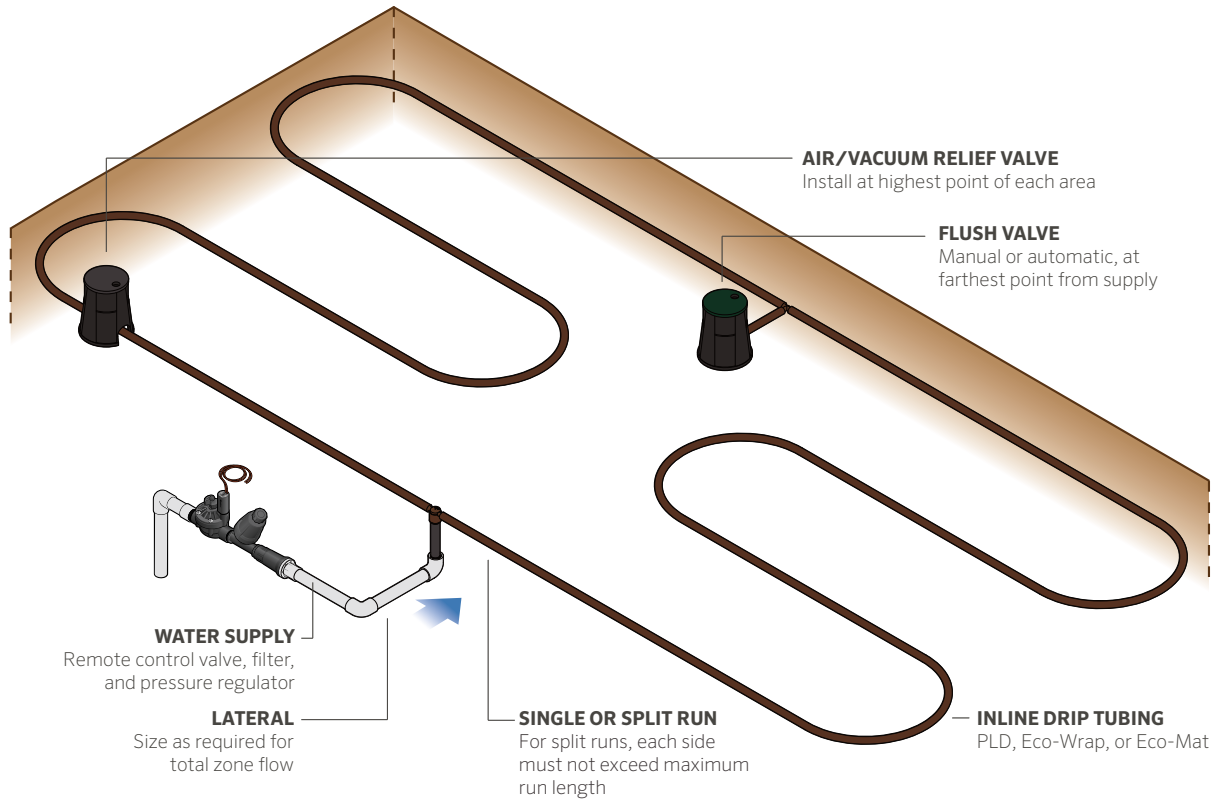

Elevation Changes

Gravity affects water movement in the soil in all slopes, but generally increases noticeably on slopes greater than 5%. Areas above the slope, below the slope, and on slope should be zoned separately. If not able to be zoned separately, the line spacing of the bottom third of the slope should be increased by 25% to equalize distribution due to gravity.

All Hunter inline drip products include built-in check valves tested to hold a minimum of 5 ft. of water. For elevation differences greater than 5 ft., design separate zones or include check valves at every 4.5 ft. of elevation change.

NOTES: Make sure anti-siphon, atmospheric or pressure vacuum breaker assemblies are at least 12" above the highest emitter. Consult local codes for installation methods, approvals, and guidance.

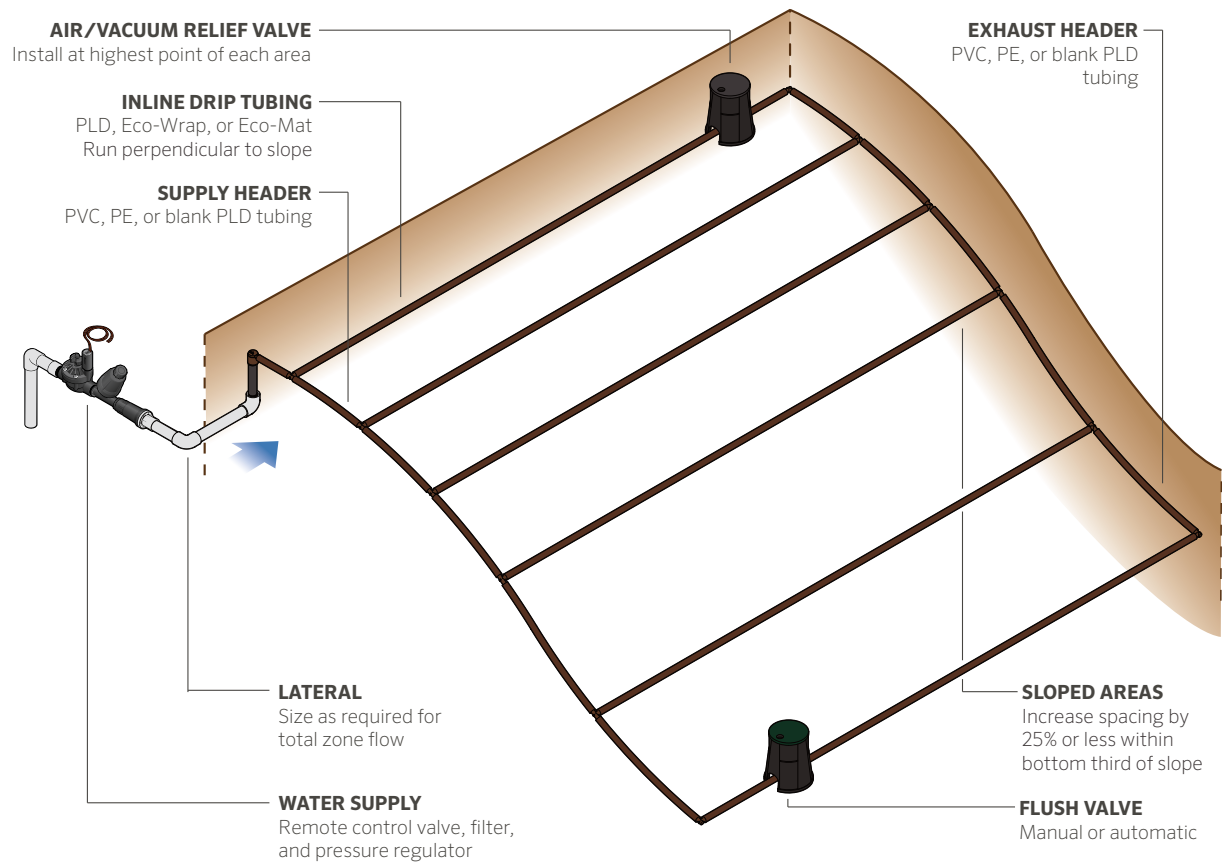

Small Planters

Small planters, such as parking lot islands, can be grouped together if they share the same plant type and microclimate factors. Be sure to install an air/vacuum relief valve at each localized high point and provide flushing for all tubing areas.

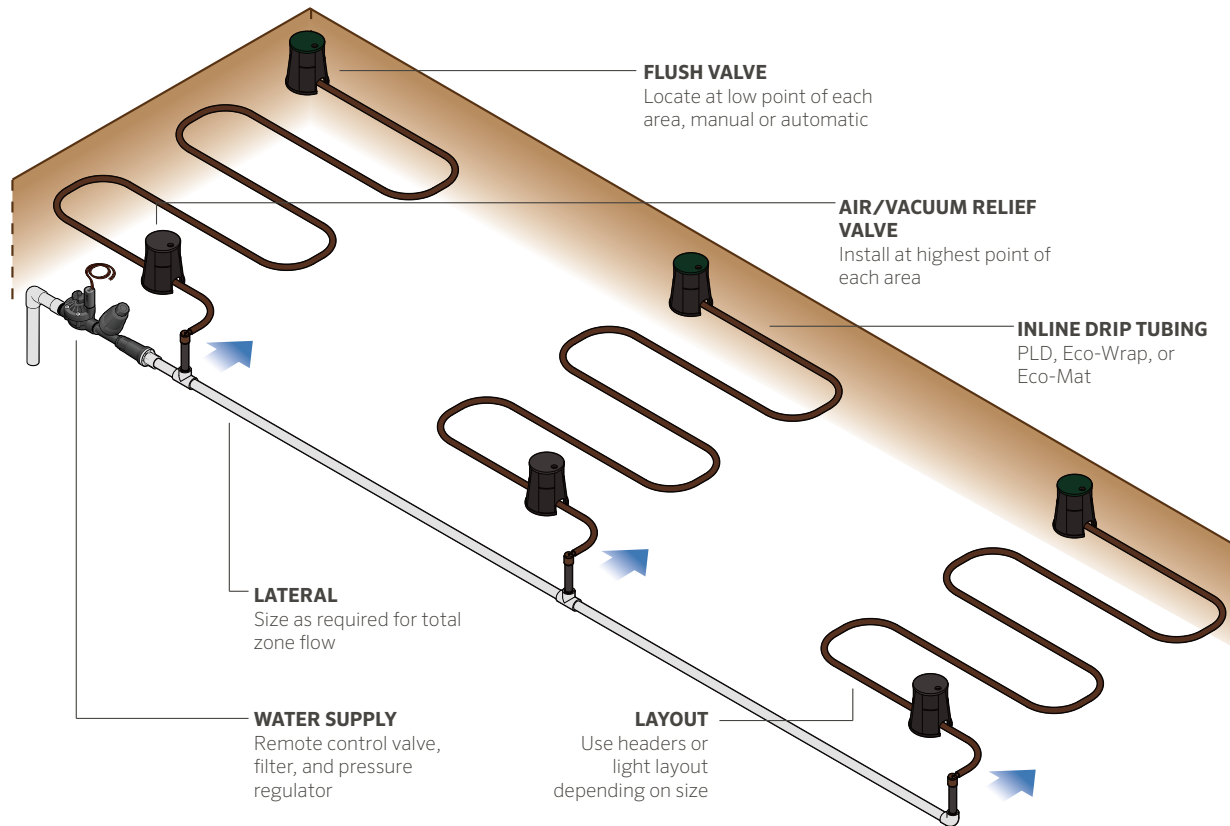

Trees

Larger plants like trees have an increased leaf area and a higher water demand, which may exceed the needs of other plants in the local hydrozone. Box out around large trees and shrubs with PLD or Eco-Wrap, installing additional rings within the expected drip line to provide needed water. Alternatively, a separate irrigation zone can be designed using a Hunter Root Zone Watering System or bubblers.

For more information about these products, see <http://www.hunterindustries.com>. Eco-Mat is not recommended for large plants with roots that typically exceed 12".

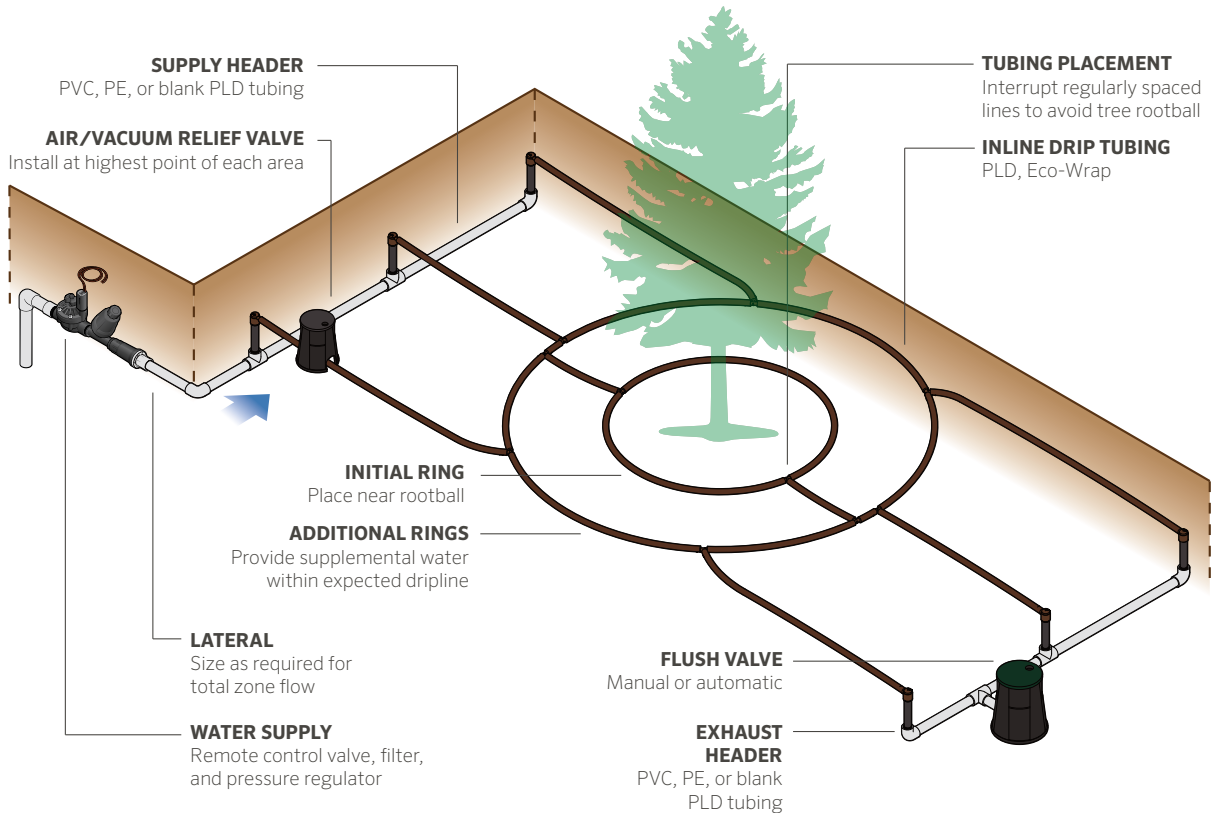

CALCULATIONS

Application Rate

The following table lists application rates for various line spacing:

EMITTER FLOW RATE - 1.0 GPH				EMITTER FLOW RATE - 0.6 GPH				EMITTER FLOW RATE - 0.4 GPH			
Row Spacing (in.)	Emitter Spacing (in.)			Row Spacing (in.)	Emitter Spacing (in.)			Row Spacing (in.)	Emitter Spacing (in.)		
	12	18	24		12	18	24		12	18	24
12	1.60	1.07	0.80	12	0.96	0.64	0.48	12	0.64	0.43	0.32
14	1.38	0.92	0.69	14	0.83	0.55	0.41	14	0.55	0.37	0.28
16	1.20	0.80	0.60	16	0.72	0.48	0.36	16	0.48	0.32	0.24
18	1.07	0.71	0.53	18	0.64	0.43	0.32	18	0.43	0.29	0.21
20	0.96	0.64	0.48	20	0.58	0.39	0.29	20	0.39	0.26	0.19
24	0.80	0.53	0.40	24	0.48	0.32	0.24	24	0.32	0.21	0.16

Notes

Application rates in inches per hour

For other spacing, calculate the application rate of each similar zone by using the following formula:

$$\frac{231.1 \times \text{Emitter Flow Rate (GPH)}}{\text{Emitter Spacing (in.)} \times \text{Line Spacing (in.)}}$$

Total Flow within a Zone

Total zone flow can be calculated by either the area method or total length method:

Zone Flow by Area Method (estimate)

$$\frac{\text{Irrigated Area (ft}^2\text{)} \times 144}{\text{Emitter Spacing (in.)} \times \text{Line Spacing (in.)}} \times \text{Emitter Flow Rate (GPH)} \div 60 = \text{Zone flow (GPM)}$$

Zone Flow Total Length Method

$$\frac{\text{Total Length} \times \text{Emitter Flow Rate (GPH)}}{\text{Emitter Spacing (in.)}} \div 60 = \text{Zone flow (GPM)}$$

Total Length within an Area (Estimated)

$$\frac{\text{Irrigated Area (ft}^2\text{)} \times 12}{\text{Minimum Row Spacing (in.)}} = \text{Estimate of total length (ft.)}$$

Maximum Inline Tubing Length Based on Flow

$$\frac{\text{Available flow (GPM)}}{\text{Flow per 100 ft.}} \times 100 = \text{Maximum length (ft.)}$$

Quantity of Emitters within a Zone

$$\frac{\text{Total length} \times 12}{\text{Emitter spacing}} = \text{Number of emitters in a zone}$$

NOTES: Consider conservatively adjusting estimates upward to account for decreased line spacing at edges and unforeseen conditions. Additional calculations and reference data can be found in *The Handbook of Technical Irrigation Information*, available at: <http://www.hunterindustries.com>.

INSTALLATION

PREPARATION

PLD can be installed at grade or shallow subsurface applications and Eco-Wrap can be installed in all subsurface applications. Either can be installed by a variety of methods:

- Pre-graded and excavated
- Vibratory plow
- With line pulling equipment
- Trenching (with a narrow blade rotary trencher or by hand)

Eco-Mat requires excavation of the entire installation area. Prior to installing Eco-Mat:

- Excavate the area to the specified installation depth
- Remove any stones or sharp-edged objects and create an even subgrade
- Note the location of each valve, the mainline, trees and large shrubs, and other objects

Ensure that all required materials, fittings, and accessories are available prior to laying inline drip tubing. Lay out only as much tubing as can be connected and flushed in one continuous operation. Otherwise, the chances of dirt and other foreign particles in the system increase.

Aerated Areas

Where aeration may occur, be sure to install subsurface drip tubing 6" below finished grade and ensure that aeration occurs at depths no greater than 4".

Graded Area

Prepared for Eco-Mat installation



PROCEDURE

General Guidelines

Proper installation is crucial to the effectiveness and long-term operation of any inline drip system. Observe the following guidelines:

- Keep all pipes and fittings clear of dirt and debris, protect exposed ends by taping or plugging while assembling other components
- Flush the system thoroughly prior to installing the last connections on every header
- Install all inline drip products at an even depth throughout each zone
- Use loop-type galvanized fabric staples or pins to keep tubing or mat in place
- Verify the location of each air/vacuum relief valve in field, ensuring one is installed at each localized high point

Headers can be constructed of PE, PVC, or blank drip tubing, depending on the size of the irrigated area. The PLD tubing inside Eco-Mat and Eco-Wrap have a diameter of 17 mm. Use 17 mm insert fittings to connect inline tubing to the headers, using either drill-in grommet fittings or tees. Ball valves or automatic flush valves should be installed at the end of the exhaust header and are necessary for flushing inline drip tubing.

NOTES: For grommet installation, verify the minimum pipe diameter needed to fully seat the fitting—often 1¼".

Eco-Mat Placement

Follow these guidelines when placing Eco-Mat:

- Place Eco-Mat in parallel rows across the entire irrigated area
- Place rows perpendicular to slopes
- Box out larger shrubs and trees with root depths greater than 12" and provide another irrigation method
- For gently curved areas, cut the fleece at minimal intervals to allow the mat to follow the curve

Rows should overlap by about 12%, or 4". This provides physical contact between mats, ensuring water will be distributed over the entire irrigated area. At edges abutting significant reflective surfaces or thermal masses, exposed to wind, or with other micro-climactic factors, the mat may be rolled under itself to position the tubing within about 8" of the edge.

NOTES: Install with the tubing facing up.

Protection

During and after installation, keep off the already installed inline drip tubing or mat and be careful when working around the product. Otherwise, the tubing may be damaged.

On slopes, use sod stakes or fabric pins to secure PLD, Eco-Mat and Eco-Wrap.

Connection

Carefully insert the inline tubing over the insert fitting, applying firm pressure and twisting slightly. Do not "screw" the inline tubing in one direction. Do not stretch the inline drip tubing, but allow a slight amount of slack along the line and between headers.

Backfilling

In general, a slightly sandy soil (sandy loam) is ideal as a planting medium when using subsurface drip irrigation. This is because "medium" textured soils have the greatest amount of water available to plants due to lesser capillary forces, even though they hold less overall water than clay soils. This also allows irrigation scheduling with (relatively) increased intervals and the greatest amount of water to be applied per cycle.

For excavated installations, backfilling on top of the installed PLD, Eco-Wrap or Eco-Mat can be done by hand or with a variety of machines. To avoid damage to the inline drip tubing, do not operate mechanized equipment directly on the installed product. Backfill with a layer of soil first. Be sure that the soil does not contain any large or sharp-edged stones or construction debris as this may cause damage to the inline drip tubing. Spread backfill material perpendicular to the line layout to minimize shifting the row spacing.

Proper compaction is essential to capillary movement of water through the soil, and, thus, the performance of any subsurface drip system. Excessively "fluffy" soils have significant air pockets which may prevent the even distribution of water. Typical compaction for planted areas is between 80-85% relative density, which must be uniform throughout the planted area.

Leak Testing

Prior to backfill, the installed areas should be tested for leaks. Every zone should be operated for 20-30 minutes and observed. Wetting patterns should be regularly sized and evenly spaced. Eco-Mat should fill evenly. If any leaks are observed, they must be repaired. If this test is not possible prior to backfilling, it should still be conducted prior to planting. Run each valve until wetted areas appear at the surface and follow the same procedure above.

Operation Indicators

To provide a visual indication that a subsurface system is operating, consider installing a pop-up spray body with a blank nozzle within each zone. The pressure of the system will raise the stem and provide a convenient location for attaching a pressure gauge to test operating pressure.

When using Eco-Mat, a 9" round or standard rectangular valve box may be installed to visually inspect the moisture penetration of the mat.



OPERATION AND MAINTENANCE

INITIAL OPERATION

Before the initial operation, all pipes should be flushed with open flush valves on exhaust headers to remove any debris in the inline drip tubing.

During plant establishment you'll need to irrigate close to or at the soil's maximum carrying capacity to train roots to grow toward the wetted area. Once the roots are established, overhead irrigation can be stopped. This typically takes from three to six weeks.

When germinating seed, overhead irrigation is essential, in addition to regular operation of the inline irrigation system. The overhead irrigation can be stopped when the seedlings and roots develop.

When establishing sod, run the subsurface irrigation system long enough to reach the soil's carrying capacity until the roots knit with the soil. Ensure proper contact between the sod and the wetted soil by rolling. Overhead irrigation is recommended when the sod is first installed (to water in the sod and prevent drying out) and generally is not otherwise needed.

Especially during the first weeks after the installation of any irrigation system, the system should be inspected regularly to verify appropriate water application and adjust irrigation scheduling as required.

Recommended System Inspection

1. Review the installation and make sure the specified components have been installed. Check markings on the inline drip tubing to ensure authentic Hunter products have been used. Verify row spacing (and for PLD, emitter spacing per specified product).
2. Verify the following are installed and check for leaks while operating:
 - Water source
 - Control valve
 - Filter, including specified filter element
 - Tubing and connections
 - Air relief valves
 - Flush valves
3. Run the system for an extended period and observe the wetted pattern (if possible). Verify consistent wetting pattern is evident on the surface.
4. Measure the pressure at the control valve and at each flush valve. Record the pressure and note for reference to aid future troubleshooting.
5. Note the current controller schedule per valve, including run time, days per week, and flow (if available).

SCHEDULING

If no regular operating schedule has been prepared, the controller may be programmed using recommended times listed in the chart below as a guideline. The values in the table below are based on broad generic information (without considering specific plant, climate, or soil conditions). The optimum run time and frequency will depend on many factors.

For all inline drip products, pulsing (scheduling several shorter irrigation phases per day instead of one long phase) promotes capillary distribution of water. This

avoids saturating the soil and is recommended for any run time longer than 12 minutes. Pulsing can be done by setting multiple start times or using Hunter controllers with an automatic “Cycle and Soak” feature. For more information, see <http://www.hunterindustries.com>.

Scheduling is key to preventing root intrusion. By maintaining a consistent and healthy level of moisture in the soil, roots will exhibit strong and consistent growth and will not need to seek out “new” sources of water.

SUGGESTED RUN TIMES FOR IRRIGATION SYSTEMS WITH PLD, ECO-WRAP, AND ECO-MAT*

Plant Type	Climate	Establishment Period	Regular Maintenance
Turf and High Water Use Plants	Arid	23-53 min/day	21-35 min/day
	Semi-arid	27-45 min/day	18-30 min/day
	Sub-Humid	23-38 min/day	15-25 min/day
	Humid	14-23 min/day	9-15 min/day
Medium Water Use Plants	Arid	20-33 min/day	13-22 min/day
	Semi-arid	17-29 min/day	11-19 min/day
	Sub-Humid	15-24 min/day	10-16 min/day
	Humid	9-15 min/day	6-10 min/day
Low Water Use Plants	Arid	9-14 min/day	6-9 min/day
	Semi-arid	8-12 min/day	5-8 min/day
	Sub-Humid	6-11 min/day	4-7 min/day
	Humid	5-6 min/day	3-4 min/day

* Suggested run times are provided as a rough guide only, absent detailed calculations from the designer. Base ETo data has been averaged by climate type and by month. Daily run times are based on a 5 day per week schedule. Suggested run times must be adjusted by the on-site irrigation manager to specific site conditions.

MAINTENANCE

Flushing

Flushing inline drip irrigation systems is a crucial maintenance procedure. If used, automatic flushing valves help avoid, but may not prevent, particulate build-up. At a minimum, manual flushing and visual inspection of the water is recommended annually. To manually flush a system with automatic flush valves, disassemble or remove the flush valves first.

Injectors

Injection systems are relatively inexpensive, provide an easy-to-use way to apply a wide variety of solutions, and add great flexibility to maintaining inline drip irrigation tubing. Mild solutions of chlorine or acid can be applied to treat potential biological growth or water quality problems.

Water with significant amounts of dissolved minerals (hard water) may leave calcium deposits, which over time restrict or impede water flow. When designing for systems with hard water, consider an injection system to allow periodic applications of a mildly acidic solution to dissolve these deposits.

NOTES: Consult local codes for installation methods, approvals, and guidance. Most jurisdictions require a reduced pressure dedicated backflow assembly for an injection system.

Winterization

In areas with freezing climates, winterization is needed to remove enough water from the irrigation system to ensure freezing and expansion of water do not crack the components. This should be done with a high-volume air compressor. Open all manual flush valves and disassemble all automatic flush valves. Ensure the pressure when blowing out the system does not exceed 50 PSI. It's the volume of air, not pressure, which effectively removes water. Note: The pressure regulator installed with an irrigation system will not regulate air pressure.

Repair

Inline drip tubing is easy to repair:

- Locate the point of damage by tracing any visible water back to the break or puncture
- Expose the line and cut out the damaged portion
- Run the system to thoroughly flush the lines from both sides
- Install a barbed connector to rejoin the line, or splice in a new segment of inline drip tubing

Warranty

Hunter Industries Incorporated (“Hunter”) warrants PLD Landscape Drip Line, PLD-Reclaimed Landscape Drip Line, Eco-Wrap, Eco-Mat, and PLD 17mm Barb Fittings to be free from defects in materials or workmanship under normal use for a period of five (5) years from the date of manufacture. Hunter further warrants PLD Landscape Drip Line and PLD-Reclaimed Landscape Drip Line to be free from environmental stress cracking for a period of 7 years from date of manufacture.

Fertigation System



APPENDIX A: EXAMPLE INSTALLATION DETAILS

NOTES: Additional installation details available on the product pages under the resources tab at www.hunterindustries.com

PLANTING BED (not to scale)

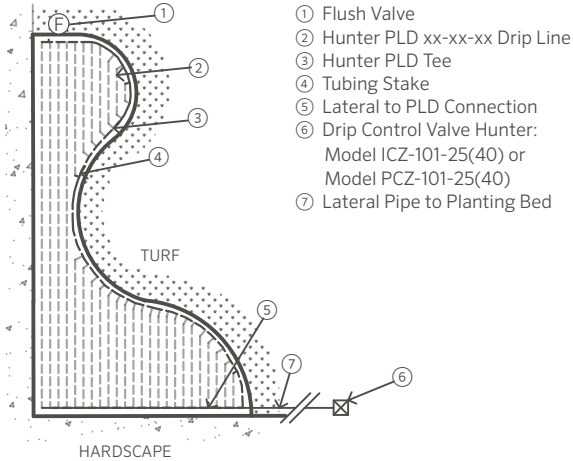

- ① Flush Valve
- ② Hunter PLD xx-xx-xx Drip Line
- ③ Hunter PLD Tee
- ④ Tubing Stake
- ⑤ Lateral to PLD Connection
- ⑥ Drip Control Valve Hunter: Model ICZ-101-25(40) or Model PCZ-101-25(40)
- ⑦ Lateral Pipe to Planting Bed

PARKING LOT: MULTIPLE ISLAND TIPS (not to scale)

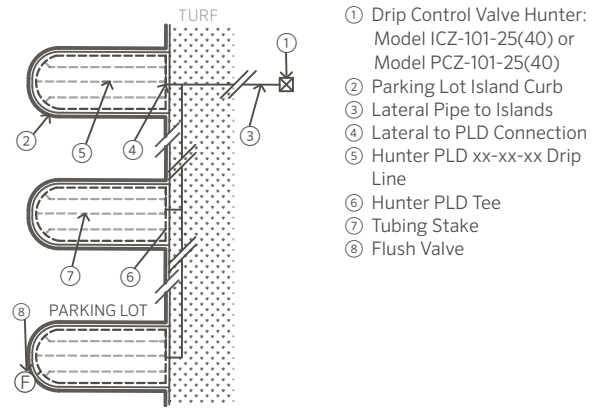

- ① Drip Control Valve Hunter: Model ICZ-101-25(40) or Model PCZ-101-25(40)
- ② Parking Lot Island Curb
- ③ Lateral Pipe to Islands
- ④ Lateral to PLD Connection
- ⑤ Hunter PLD xx-xx-xx Drip Line
- ⑥ Hunter PLD Tee
- ⑦ Tubing Stake
- ⑧ Flush Valve

Notes:

1. Size emitter flow and spacing based on plant and soil type
2. Row spacing of PLD tubing based on plant and soil type
3. Stake tubing down every 5' and within 1' of all fitting outlets
4. Do not exceed velocity of 5 FPS within tubing, if size of drip area creates velocities greater than 5 FPS within use standard lateral pipe to create supply header for the drip area
5. Install flush valve at point furthest from supply point
6. Thoroughly flush lateral and dripline prior to final connections
7. Test drip line for proper operation prior to covering

ECO-MAT GREEN ROOF (not to scale)

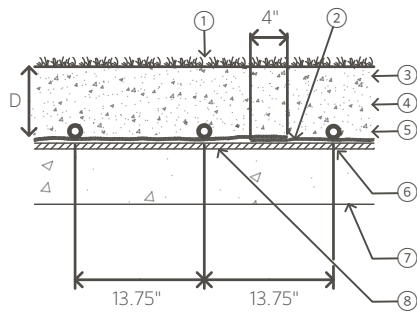

- ① Green Roof Planting (see planting plans)
- ② Overlap Mat 4"
- ③ Finished Grade
- ④ Amended Soil
- ⑤ Eco-Mat Subsurface Irrigation
- ⑥ Roof Drainage, by other division
- ⑦ Structural Roof, by other division
- ⑧ 17 mm Drip Line Tubing, Polypropylene Fleece Wrapped

Notes:

Recommended Eco-Mat Installation Depth (D):
Green Roof Areas: 2" - 6"

ECO-MAT CONNECTION (not to scale)

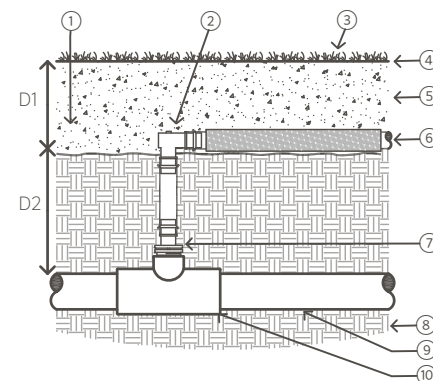

- ① Overlap Eco-Mat Over Connection and to Edge of Planted and Irrigated Area
- ② Eco-Wrap, 17 mm Barb x Barb 90° ELL
- ③ Turf Grass, Ground Covers or Shrubs (see planting plans)
- ④ Finished Grade
- ⑤ Amended Soil
- ⑥ Eco-Mat Subsurface Irrigation mat with 17 mm Drip Line Tubing, Wrapped in Polypropylene Fleece
- ⑦ PLD-075, 17 mm Barb x 3/4" MIPT Adapter, with 8" of Black PLD Tubing
- ⑧ Site Soil
- ⑨ PVC Lateral Line
- ⑩ PVC SST Tee Fitting, Lateral Size x 3/4"

Notes:

D1: Eco-Mat depth per plans
D2: 12" or per plans

APPENDIX B: TECHNICAL PRODUCT DATA

COEFFICIENT OF VARIATION

NOTES: Hunter publishes CV values for all pressures throughout the operating range. For best performance, regulate inline pressures to 30 PSI.

15 PSI - 1.2	25 PSI - 0.9	35 PSI - 1.1	45 PSI - 4.2
20 PSI - 1.7	30 PSI - 0.6	40 PSI - 3.4	50 PSI - 4.8

PLD

PLD Application Rates

EMITTER FLOW RATE - 1.0 GPH				EMITTER FLOW RATE - 0.6 GPH				EMITTER FLOW RATE - 0.4 GPH			
Row Spacing (in.)	Emitter Spacing (in.)			Row Spacing (in.)	Emitter Spacing (in.)			Row Spacing (in.)	Emitter Spacing (in.)		
	12	18	24		12	18	24		12	18	24
12	1.60	1.07	0.80	12	0.96	0.64	0.48	12	0.64	0.43	0.32
14	1.38	0.92	0.69	14	0.83	0.55	0.41	14	0.55	0.37	0.28
16	1.20	0.80	0.60	16	0.72	0.48	0.36	16	0.48	0.32	0.24
18	1.07	0.71	0.53	18	0.64	0.43	0.32	18	0.43	0.29	0.21
20	0.96	0.64	0.48	20	0.58	0.39	0.29	20	0.39	0.26	0.19
24	0.80	0.53	0.40	24	0.48	0.32	0.24	24	0.32	0.21	0.16

Notes

Application rates in inches per hour

PLD Flow Conversion Chart

QUICK REFERENCE CHART - GPM PER 100'

Emitter (GPH)	Emitter Spacing (in.)		
	12	18	24
0.4	0.67	0.44	0.33
0.6	1.00	0.67	0.50
1.0	1.67	1.11	0.83

ECO-WRAP

- Outside diameter drip pipe: 17 mm
- Quantity of water per dripper: 0.6 GPH, pressure compensating, non-draining
- Emitter spacing: 12"
- Outside diameter of enveloped pipe: 14"
- Roll Length: 250 ft.
- Maximum lateral length (depends on pressure): up to 387 ft.
- Working pressure range: 15-50 PSI
- Weight per roll: 17 lbs.
- Measurement per roll:
 - Outside diameter: 36"
 - Inside diameter: 16"
 - Width: 17"
- Rolls per pallet: 20

ECO-MAT

- Outside diameter drip pipe: 17 mm
- Quantity of water per dripper: 0.6 GPH, pressure compensating, non-draining
- Distance between drippers in the pipe: 12"
- Outside diameter of enveloped pipe: 14"
- Dry weight of Eco-Mat / yd² : approximately 2 lbs.
- Wet weight of Eco-Mat (saturated) / yd² : approximately 9.5 lbs.
- Water holding capacity / yd²: 0.5 gallon
- Maximum lateral length (depends on pressure): up to 387 ft.
- Working pressure range: 15-50 PSI

ECO-MAT ROLLS

MEASUREMENT OF ROLL	WEIGHT PER ROLL	ROLLS PER PALLET
32" x 100' (267 ft')	29 lbs.	63
32" x 295' (785 ft')	84 lbs.	4

Eco-Mat Stacked Rolls



FITTINGS

INSERT FITTINGS

MODEL	DESCRIPTION
PLD050	Barb to 1/2" NPT Adapter
PLD075	Barb to 3/4" NPT Adapter
PLDCPL	Barb to Barb Coupling
PLDELB	Barb to Barb, 90° Elbow
PLDTEE	Barbed Tee
PLDCAP	Barb to End Cap
PLDBV	Barbed Valve
PLD075TBTEE	3/4" Female Thread x 17 mm Barb Tee
PLDAVR	Air Relief Valve



Helping our customers succeed is what drives us. While our passion for innovation and engineering is built into everything we do, it is our commitment to exceptional support that we hope will keep you in the Hunter family of customers for years to come.

A stylized, handwritten signature in white ink, appearing to read "G. R. Hunter".

Gregory R. Hunter, President of Hunter Industries

Website hunterindustries.com | **Customer Support** 760-744-5240 | **Technical Service** 760-591-7383

This brochure was printed on Forest Stewardship Council® (FSC) certified paper with soy inks. The FSC is an international organization established to promote the responsible management of the world's forests.

© 2012 Hunter Industries Incorporated  Please recycle.

LIT-496 B 6/15



Printed using
100% Wind
Energy, (RECs)

